

NEMO

JANUARY 2023

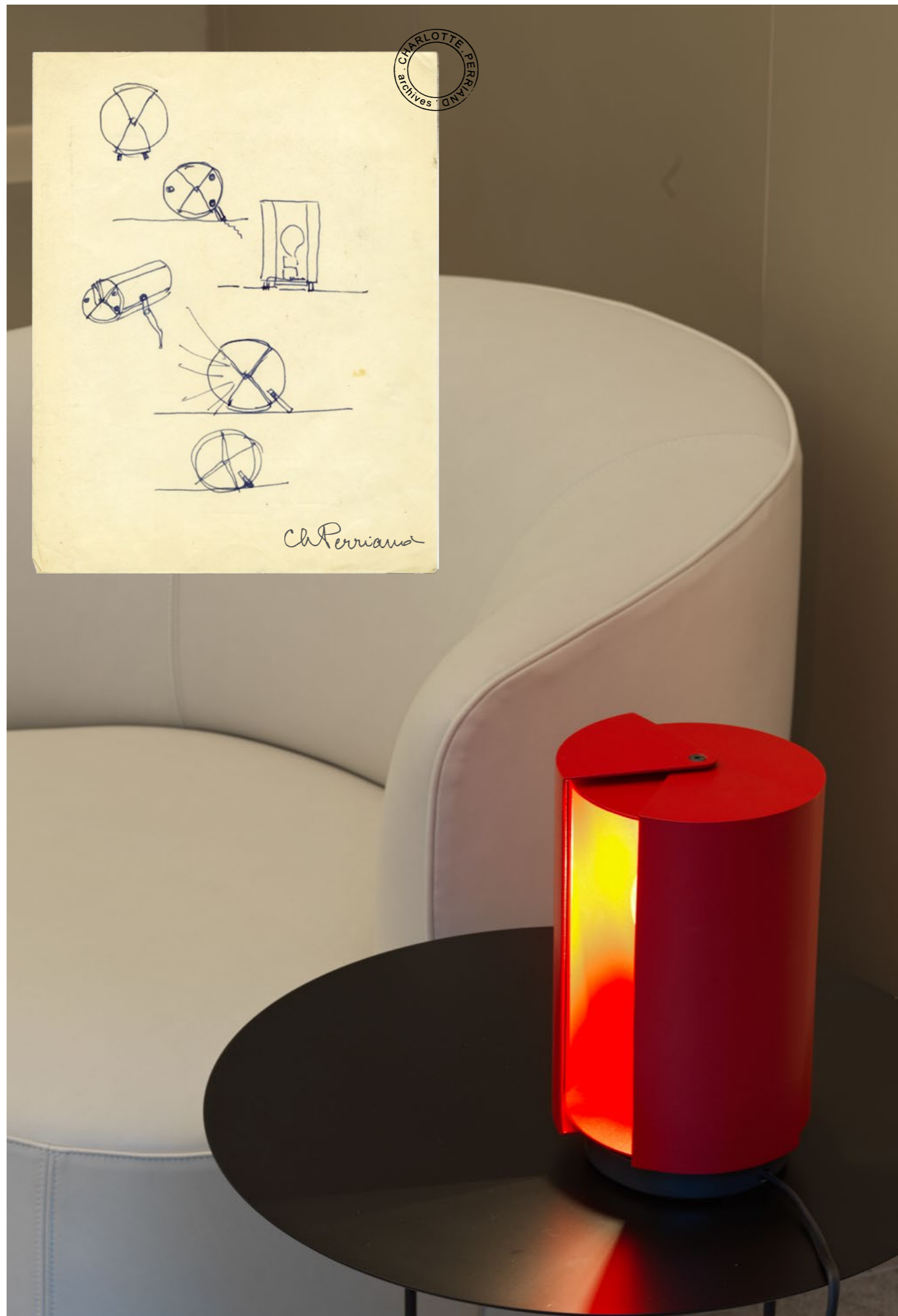



PIVOTANTE À POSER Charlotte Perriand

LED/HALO/FLUO

version	max power	source	voltage	lum. flux/CCT	switching	code	finish	Euro
	60W	E27, A60	230V			PAP EDR 12	carmine red	195,00
						PAP EDV 12	sage green	195,00
						PAP EDD 12	light grey	195,00

note switch on cable, cable length 2,5m, orientable 360°, red RAL3002, sage green RAL6021, light green RAL7046



Prices without bulb

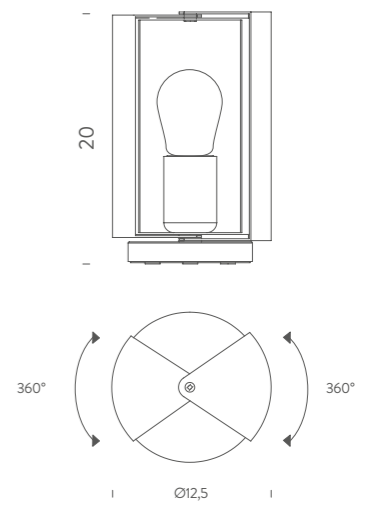
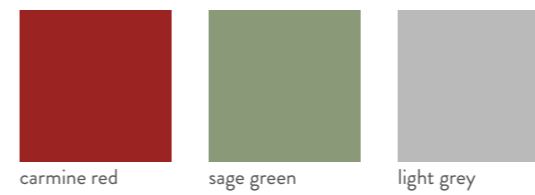





Charlotte Perriand's lightings are timeless. They are at the same time functional and minimalist, designed, as her furniture, on an architectural scale. They aren't lightings of a "designer" but of an "architect", that play with volumes and dimensions, as an architectural element of a combination, to let space "sing".

Pernette Perriand-Barsac, Jacques Barsac, Archives Charlotte Perriand

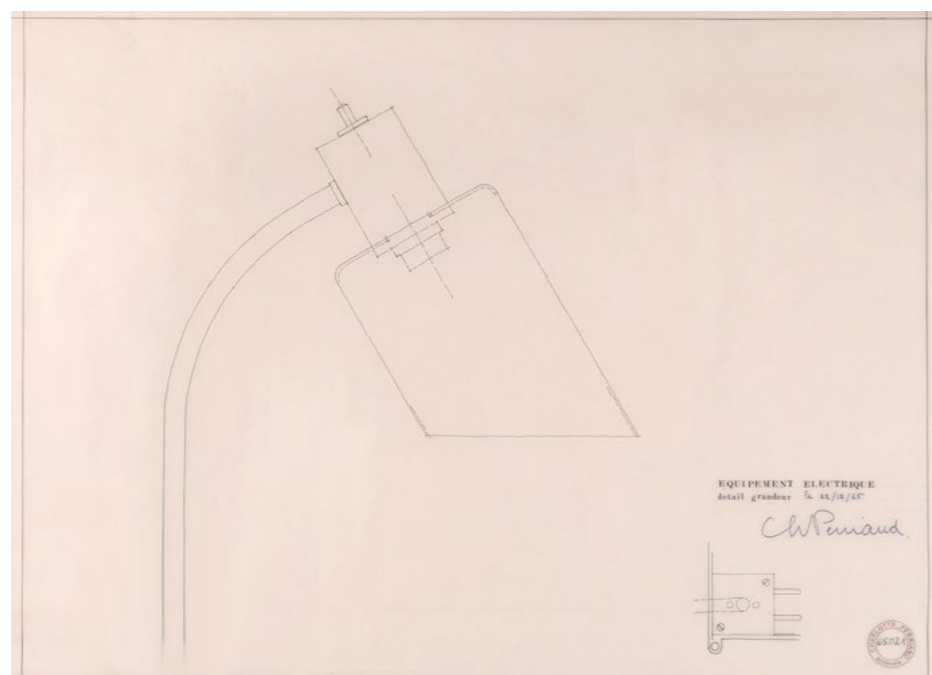

Sketch of Lampe de Bureau



LAMPE DE BUREAU READING Charlotte Perriand

LED/HALO

<i>version</i>	<i>max power</i>	<i>source</i>	<i>voltage</i>	<i>CCT</i>	<i>lum. flux</i>	<i>switching</i>	<i>code</i>	<i>finish</i>	<i>Euro</i>
	20W	E14	230V			on board	LDB EDV 21	green	395,00
							LDB EDG 21	yellow	395,00
							LDB EDR 21	red	395,00
							LDB EDB 21	blue mare	395,00
							LDB EDC 21	blue grey	395,00
							LDB EDW 21	white	395,00

note cable length 2,7m, steel base dark grey RAL7016, steel body light grey RAL7046, green, red, blue mare, blue grey and yellow glass available

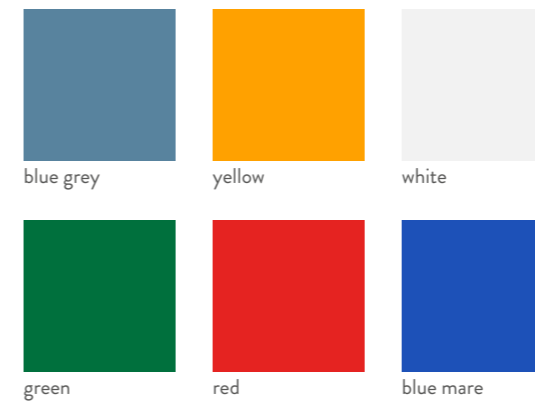
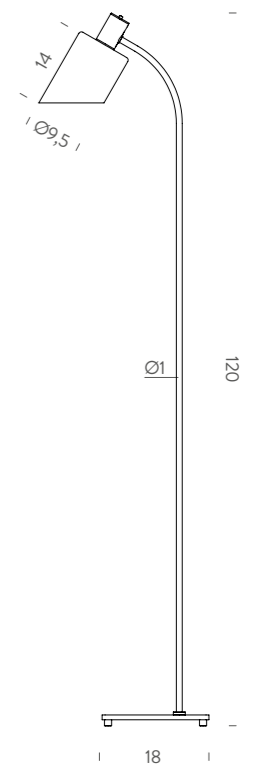
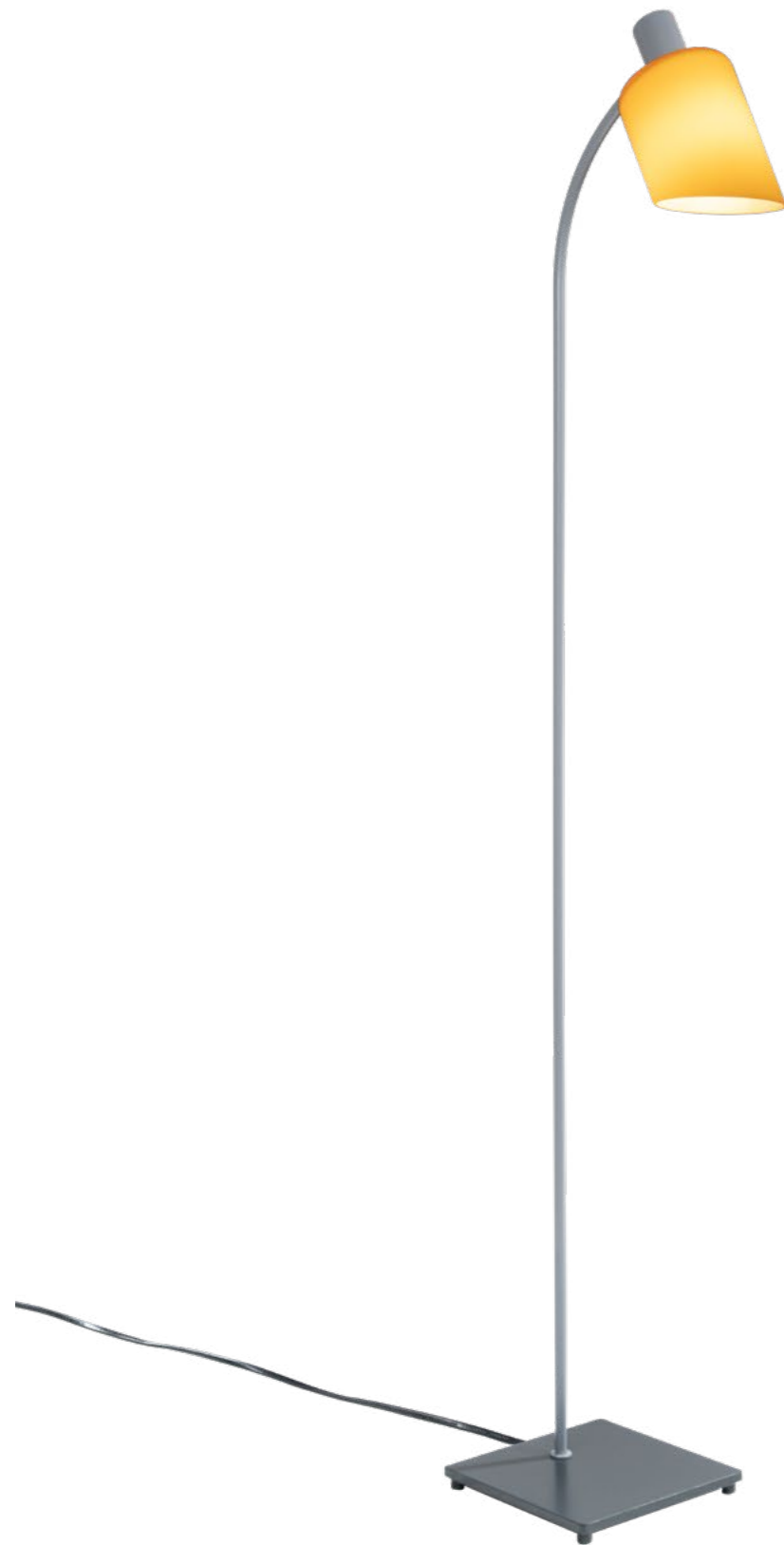



LAMPE DE BUREAU APPLIQUE Charlotte Perriand

LED/HALO

version	max power	source	voltage	CCT	lum. flux	switching	code	finish	Euro
	20W	E14	230V			on board	LDB EDV 31	green	295,00
							LDB EDG 31	yellow	295,00
							LDB EDR 31	red	295,00
							LDB EDB 31	blue mare	295,00
							LDB EDC 31	blue grey	295,00
							LDB EDW 31	white	295,00

note cable length 1,1 m, installation with or without plug, wall cover dark grey RAL7016, steel body light grey RAL7046, green, red, blue mare, blue grey and yellow glass available

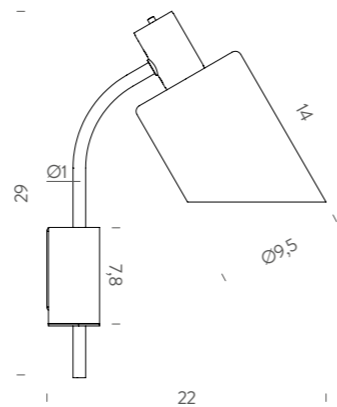
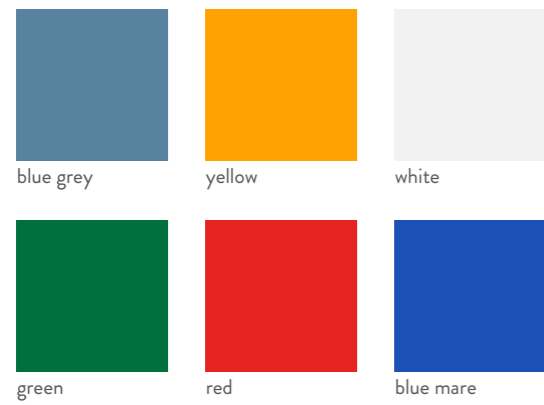



UNTITLED MINI
Bernhard Osann

UNTITLED MINI LINEAR Bernhard Osann

LED

version	max power	source	voltage	CCT	lum. flux	switching	code	finish	Euro
linear	7W	LED board	110-240V	2700K	485lm	dimnable on board	UNT LN2 15	black	205,00
				3000K	485lm	dimnable on board	UNT LNN 15	black	205,00

note accessories (base, desk clamp, wall fixing) sold separately, cable length 2m, typ cri 90



BASE



DESK CLAMP

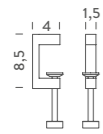

WALL FIXING

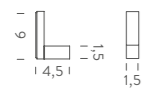

ACCESSORIES

version	code	finish	Euro
BASE	UNT BAN 11	black	50,00
DESK CLAMP	UNT ATN 11	black	50,00
WALL FIXING	UNT ATN 31	black	50,00

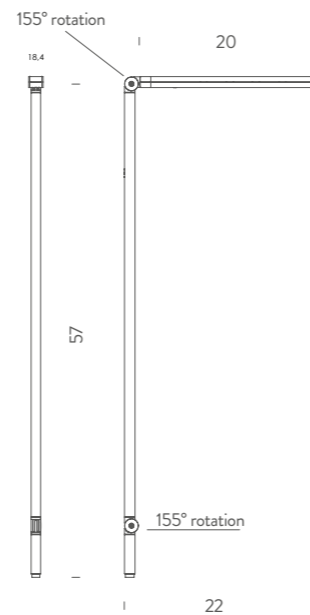



UNTITLED MINI SPOT Bernhard Osann

LED

version	max power	source	voltage	CCT	lum. flux	switching	code	finish	Euro
spot	6,5W	LED spot	110-240V	2700K	348lm	dimnable on board	UNT LN2 16	black	225,00
				3000K	348lm	dimnable on board	UNT LNN 16	black	225,00

note accessories (base, desk clamp, wall fixing) sold separately, cable length 2m, typ cri 90



BASE

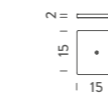

DESK CLAMP

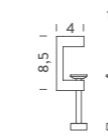

WALL FIXING

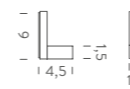

ACCESSORIES

version	code	finish	Euro
BASE	UNT BAN 11	black	50,00
DESK CLAMP	UNT ATN 11	black	50,00
WALL FIXING	UNT ATN 31	black	50,00

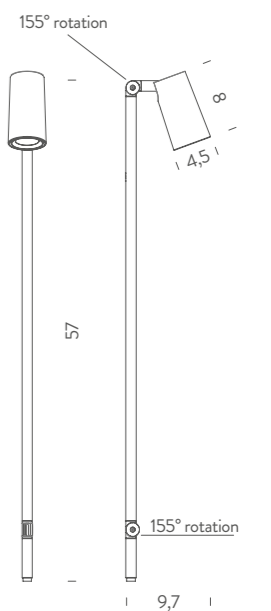

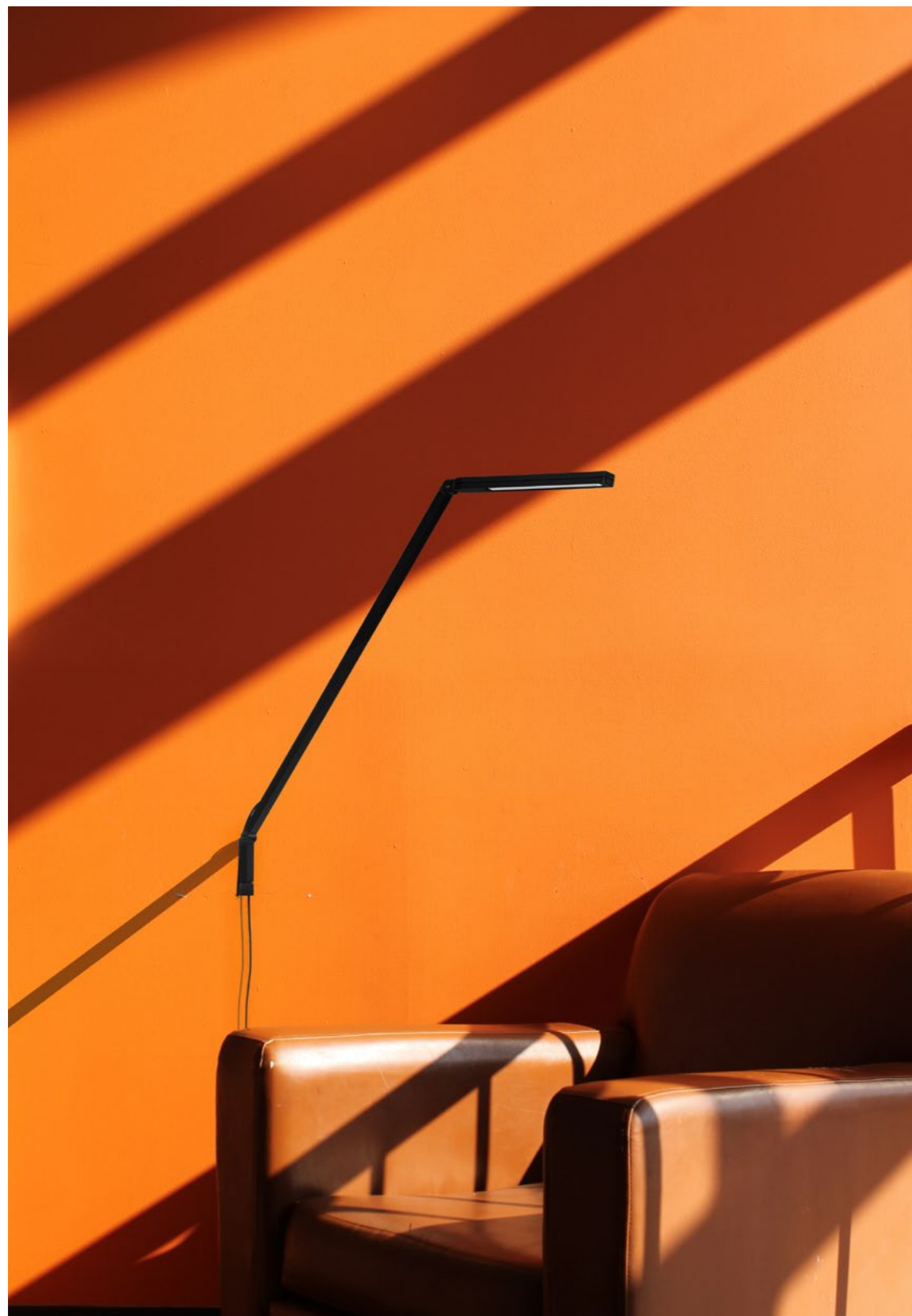

GENERAL INFORMATION

Nemo and Nemo Studio's goal is to propose cutting-edge technological solutions, also through a constant updating process. By definition, technology is changing and continuously evolving. To ensure the consultation of the latest product data, we recommend referring to the information available on our website www.nemolighting.com. This document was drafted in January 2023. It replaces and updates any other publication in relation to the listed products.

Obiettivo di Nemo e Nemo Studio è quello di proporre soluzioni tecnologiche all'avanguardia, anche tramite un continuo e costante processo di aggiornamento. Per definizione la tecnologia è mutevole ed in costante evoluzione. Sugeriamo, per assicurare la consultazione delle informazioni più recenti sui prodotti, di verificare quelle disponibili sul nostro sito www.nemolighting.com. Questo documento è stato redatto a Gennaio 2023. Sostituisce ed aggiorna qualsiasi altra pubblicazione in relazione ai prodotti elencati.

Das Ziel von Nemo und Nemo Studio ist die Entwicklung von technologischen Lösungen auf dem neuesten Stand, auch durch einen ständigen Aktualisierungsprozess. Die Technik entwickelt sich ständig weiter. Um die aktuellsten Produktunterlagen einzusehen, empfehlen wir, sich auf die Informationen auf unserer Website www.nemolighting.com zu beziehen. Dieses Dokument wurde im Januar 2023 verfasst. Es ersetzt und aktualisiert alle anderen Veröffentlichungen in Bezug auf die aufgeführten Produkte.

L'objectif de Nemo et Nemo Studio est de proposer des solutions technologiques de pointe, également à travers un processus de mise à jour constante. Par définition, la technologie évolue et change continuellement. Ce document a été rédigé en Janvier 2023. Pour garantir la consultation des dernières données produits, nous vous recommandons de vous référer aux informations disponibles sur notre site www.nemolighting.com. Remplace et met à jour toute autre publication en relation avec les produits listés.

This document supersedes and updates all previous catalogues and publications in relation to the products listed here in.

Questa pubblicazione sostituisce ed aggiorna i precedenti cataloghi con riferimento ai prodotti elencati.



The updated list of UL and ETL marked products and relevant technical information are available on the website: nemolighting.com/usa/

NEMO
NEMOLIGHTING.COM

NEMO HEAD OFFICE

Viale Brianza, 30,
20823 Lentate s/S - ITALY
Tel +39 0362 166 050 0
info@nemolighting.com

SHOWROOM MILANO

Corso Monforte 19/A,
20122 Milan
Tel +39 02 970 703 40
monforte@nemolighting.com

NEMO FRANCE | NEMO GALERIE PARIS

44, Rue du Bac
75007 Paris
Tel +33 (0) 1 40 20 47 69
Tel +33 (0) 1 486 300 77
ruedubac@nemolighting.fr
france@nemolighting.fr
nemolighting.com/fra/

NEMO USA

625 Jersey Avenue, Unit 7
New Brunswick, NJ 08901
Tel 800 734 5858
usa@nemolighting.com
nemolighting.com/usa/

NEMO STUDIO

Strada Borgata Paradiso, 20
10036 Settimo Torinese - ITALY
Tel. +39 011 765 73 01
nemostudio@nemolighting.com

NEMO BORGONUOVO 19

Via Borgonuovo 19,
20121 Milan
studio@nemolighting.com

Scan the code for Terms and Conditions



For more info visit our website

